

ISO 9001:2008 Co.

Tirupati Precast

Mfg. RCC Folding Compound Wall

Mr. Jitendra Patel

+91 9705814545

Near Ramoji Film City, Anajpur, Hyderabad

web: www.tirupatiprecasts.in



More Detail Scan QR Code

Tirupati Precast

Mfg. RCC Folding Compound Wall

Mr. Jitendra Patel

+91 9705814545



ISO 9001:2008 Co.

Tirupati Precast

Tirupati Precast

Concept for 21st Century

Tirupati Precast

COMPANY PROFILE!

We, Tirupati Precast introduce ourself as the company that cares for quality cement products. We are manufacturer of prefabricated RCC compound wall with different designs godowns, Labour quarters etc as per customer requirements.

With the culture of deep dedication to work, determination to succeed, our company today enjoys a premium position among a few indigenous class manufacturers.

Our products are manufactured under stringent norms and the raw materials procured from reputed manufacturers and suppliers are accepted through rigorous Quality control norms. All these have enabled us to maintain a host of Clients.

OUR VISION !

We, Tirupati Precast has come with " Concept of 21st Century" and ISO 9001 : 2008 Co. of RCC Pre-Cast Prestress techniques Guaranteed consumers in India Safer, Cheaper, Re-usable RCC Compound wall.

OUR MISSION !

With Quality, Quantity, Time and Services our Mission is to compound the India with this RCC Pre-Cast Wall.

Tirupati Precast

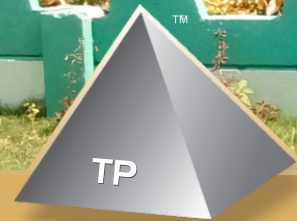

Time and cost saving Construction

Concept for 21st Century

Tirupati Precast

General Characteristics

Less Space is Utilises
Speedy Installation
Durable
Re-Installable
Better Outlook
Fully RCC with Steel
Various Designs
Aesthetic

Product Applications:

Compound Wall
Garden Curbing
Footpath Curbing
Security Cabin
Labour Quarter

Specifications

Vertical concrete posts as well as horizontal planks is cast using prestress technology with designed concrete mix to achieve maximum durability and strength.

Tirupati Precast



Garden Curbing

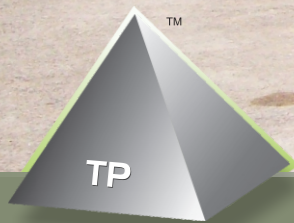

Concept for 21st Century

Tirupati Precast

Cement Sets

Length 7 Feet (2100mm)

Height 1 Feet (300mm)

Width 2.5 Inches (65mm)

We use 4 pieces of 3 mm PCC steel per set, with stressing system.

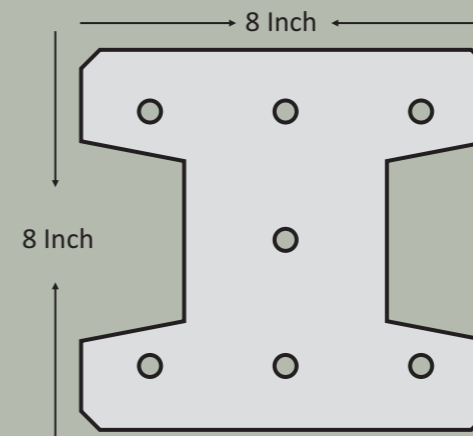
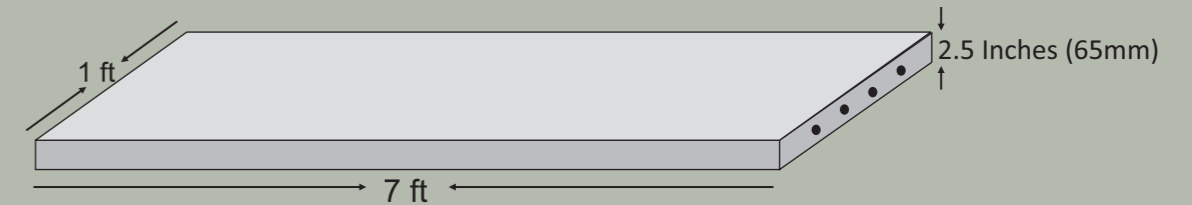

Columns

Columns are 8X8 inches. (200X200 mm)

We use 7 Pieces of 4 mm PCC Steel, with Stressing System.

Length is depend on customer's requirement.

Tirupati Precast



Security Compound wall

Tirupati Precast

Basic Design of 6 feet Prefabricated Folding Compound Wall

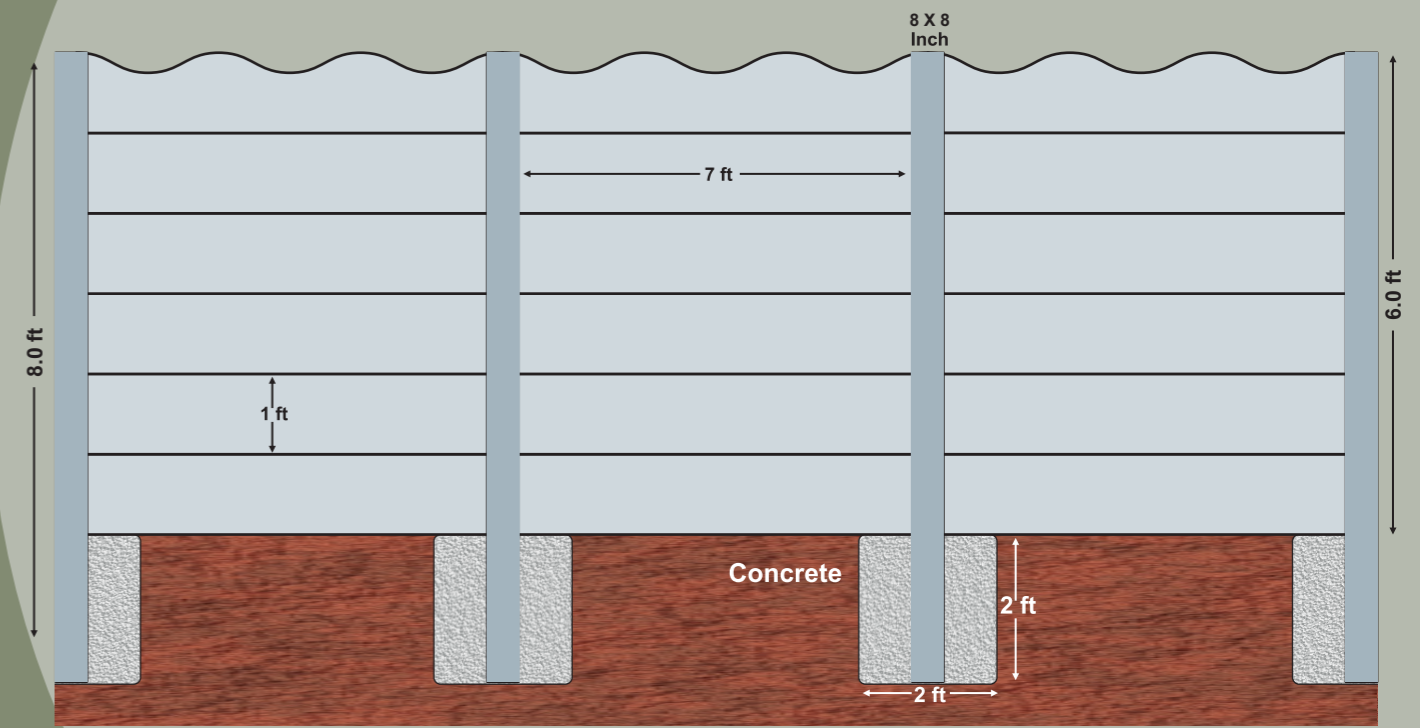

Concept for 21st Century

Available in 5 feet to 10 feet

Tirupati Precast

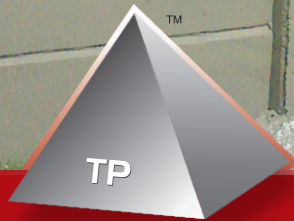

Warehouse Compound Wall

Tirupati Precast



Concept for 21st Century

Tirupati Precast

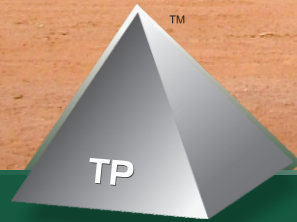

Industrial Compound Wall

Tirupati Precast

Concept for 21st Century



Tirupati Precast

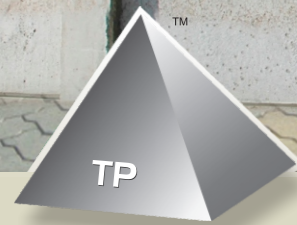

Final Finished Compound Wall

Tirupati Precast



Concept for 21st Century

Tirupati Precast

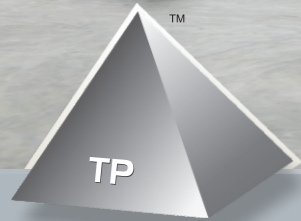

Drainage Line

Concept for 21st Century

Tirupati Precast

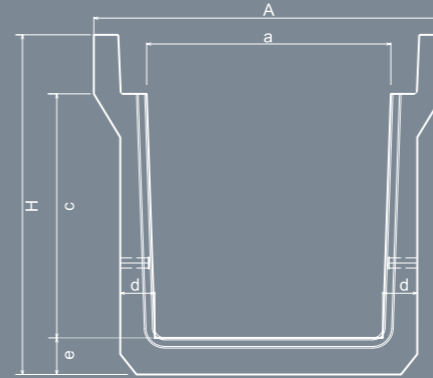

SECTION

| Size(mm) | Dimensions of U Shape Drain (mm) | | | | | | |
|-----------|----------------------------------|-----|-----|-----|-----|----|----|
| a x c | L | A | H | a | c | d | e |
| 450 x 450 | 2000 | 700 | 660 | 450 | 450 | 75 | 80 |
| 600 x 600 | 2000 | 860 | 835 | 600 | 600 | 85 | 90 |

| Drain Size (mm) | Dimensions of Cover (mm) | | |
|-----------------|--------------------------|-----|-----|
| A' x B' | A' | B' | H |
| 450 x 450 | 500 | 565 | 130 |
| 600 x 600 | 500 | 710 | 140 |

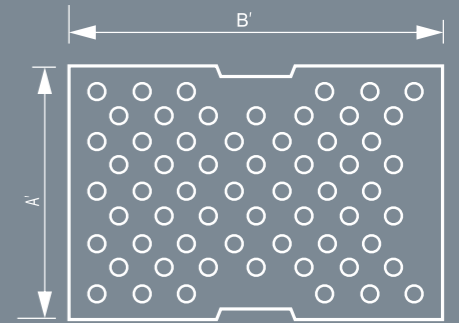

Cover Plan

Tirupati Precast



Security Compound wall

Tirupati Precast

Some of Our Valuable Customers

- Wonderla Holidays Ltd, Hyderabad
- Natco Pharma Ltd, Kothur
- IIIT (Deemed University) Gachibowli, Hyderabad
- Polar Auto Pvt Ltd, Zahirabad
- Bhuvna Construction Ballare, Karnataka
- Crest Cellulose Pvt Ltd, Naidupet, Nellore
- Kandakatla Estates Pvt Ltd, Hyderabad
- Pranav Infra, Hyderabad
- K N R Construction, Hyderabad
- Gel Caps Industries, Naidupet, Nellore
- Tirumala Estate, Vinukonda, Guntur
- Ramoji Foundation
- Greenko Salar, Karnool
- Suzlon Power, Mehboobnagar
- BE Electric, Tondur
- Alstom Power, Shabbad

Concept for 21st Century